



Features

- Shielded construction – low radiation
- Bifilar wound
- Impedance range: 90 to 2200 ohms @ 100 MHz
- AEC-Q200 qualified
- RoHS compliant* and halogen free**

Applications

- EMI suppression for:
 - Data and signal lines
 - CANbus
 - Automotive electronics
 - Consumer electronics
 - Telecom devices

SRF3216A Series - Common Mode Chip Inductors

Electrical Specifications @ 25 °C

Bourns Part Number	Impedance @ 100 MHz / 1 V		DCR Typ. (Ω)	DCR Max. (Ω)	I _{rms} (mA)
	Z (Ω)	Tolerance (%)			
SRF3216A-900Y	90	± 25	0.15	0.3	400
SRF3216A-121Y	120	± 25	0.17	0.3	350
SRF3216A-161Y	160	± 25	0.18	0.4	350
SRF3216A-221Y	220	± 25	0.25	0.45	300
SRF3216A-261Y	260	± 25	0.35	0.5	300
SRF3216A-361Y	360	± 25	0.45	0.6	300
SRF3216A-601Y	600	± 25	0.60	0.8	300
SRF3216A-102Y	1000	± 25	0.65	1.0	230
SRF3216A-222Y	2200	± 25	1.10	1.2	200

Soldering Profile

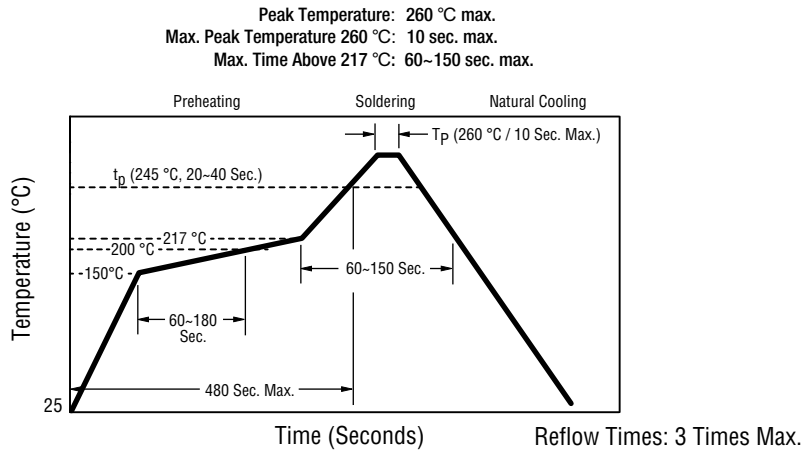

How to Order

SRF3216A - 221 Y

Model _____
 Value Code (see table) _____
 Tolerance Code _____

Schematic

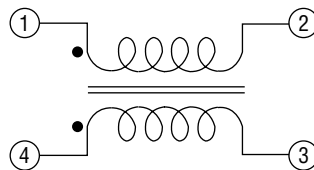

General Specifications

Rated Voltage 50 VDC
 Withstanding Voltage 125 VDC
 Insulation Resistance 10 megohms min. @ 100 VDC
 Operating Temperature -55 °C to +125 °C
 (Temperature rise included)
 Storage Temperature -55 °C to +125 °C
 Temperature Rise 20 °C at rated I_{rms}

Materials

Core Ferrite
 Wire Enameled copper
 Terminal Finish Sn
 Packaging 2000 pcs. per 7-inch reel

Product Dimensions

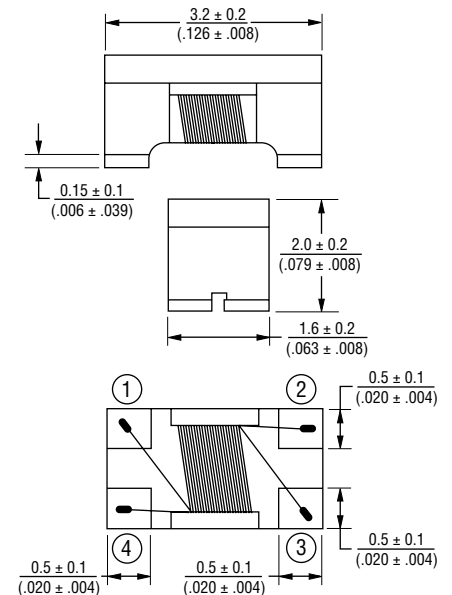

Recommended Layout

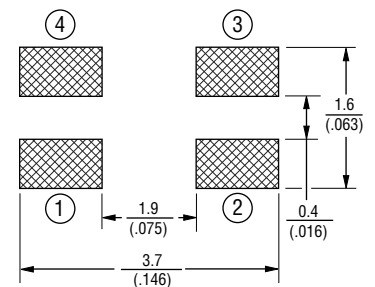

DIMENSIONS: $\frac{\text{MM}}{\text{(INCHES)}}$

* RoHS Directive 2002/95/EC Jan. 27, 2003 including annex and RoHS Recast 2011/65/EU June 8, 2011.

**Bourns considers a product to be "halogen free" if (a) the Bromine (Br) content is 900 ppm or less; (b) the Chlorine (Cl) content is 900 ppm or less; and (c) the total Bromine (Br) and Chlorine (Cl) content is 1500 ppm or less.

Specifications are subject to change without notice.

The device characteristics and parameters in this data sheet can and do vary in different applications and actual device performance may vary over time.

Users should verify actual device performance in their specific applications.

SRF3216A Series - Common Mode Chip Inductors

BOURNS®

Typical Impedance vs. Frequency Curves

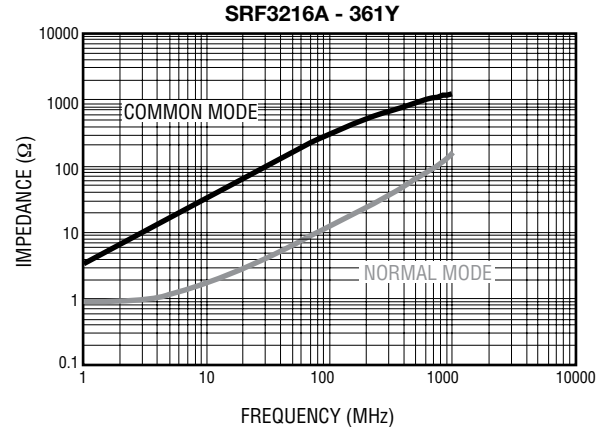
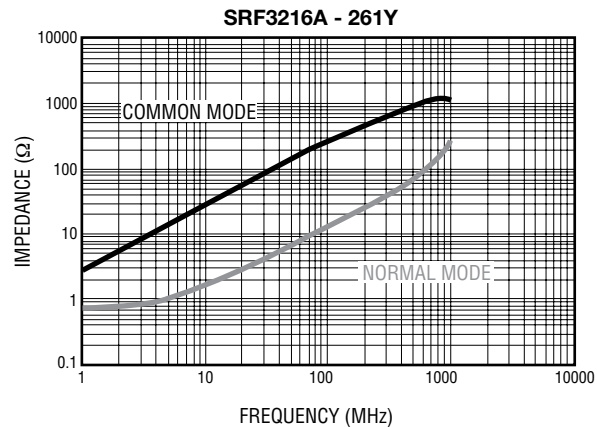
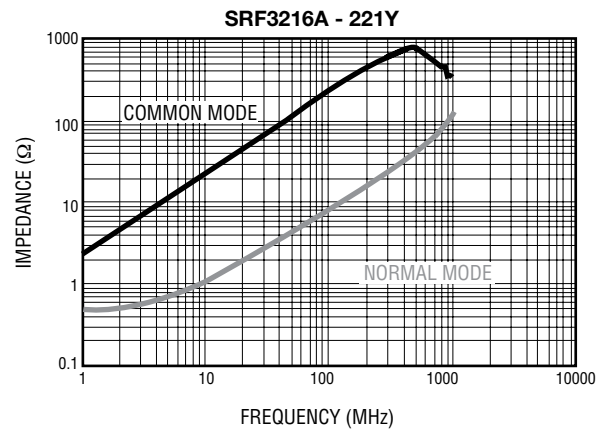
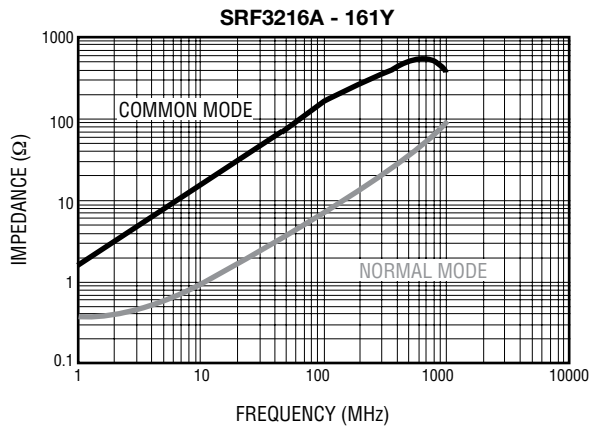
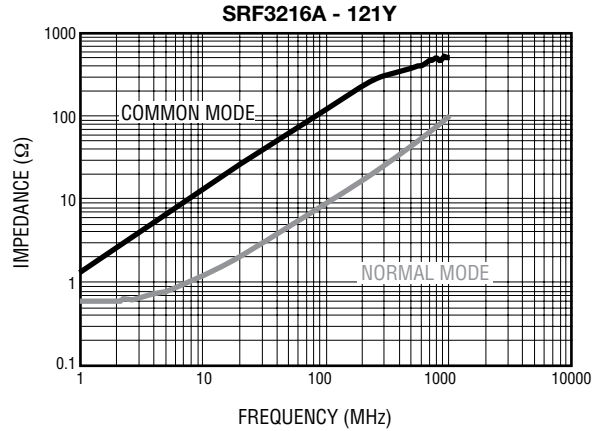
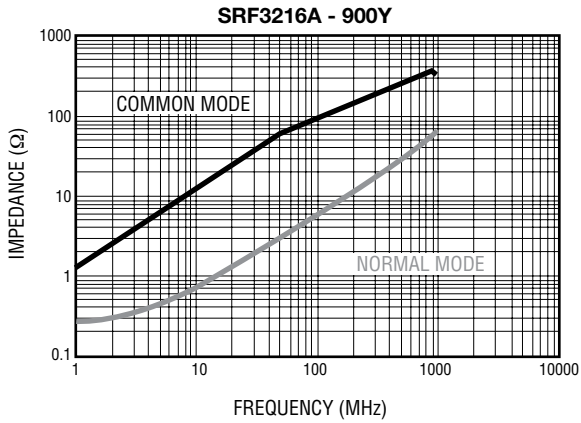

Specifications are subject to change without notice. The device characteristics and parameters in this data sheet can and do vary in different applications and actual device performance may vary over time. Users should verify actual device performance in their specific applications.

SRF3216A Series - Common Mode Chip Inductors

BOURNS®

Typical Impedance vs. Frequency Curves (Continued)

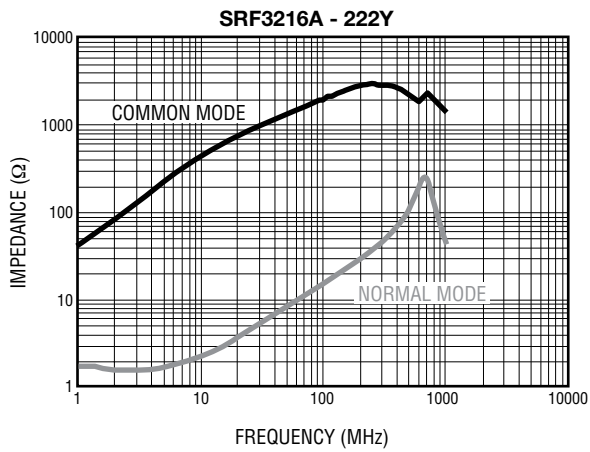
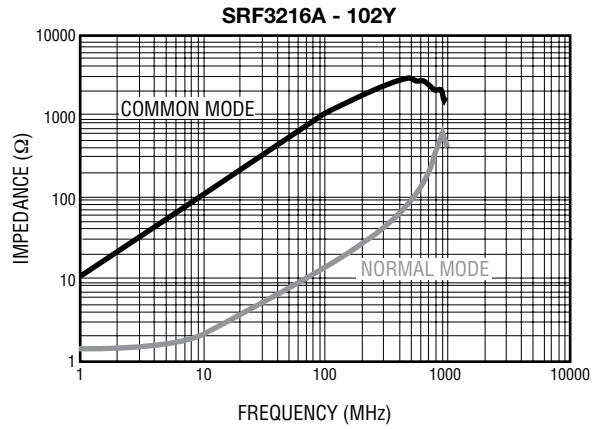
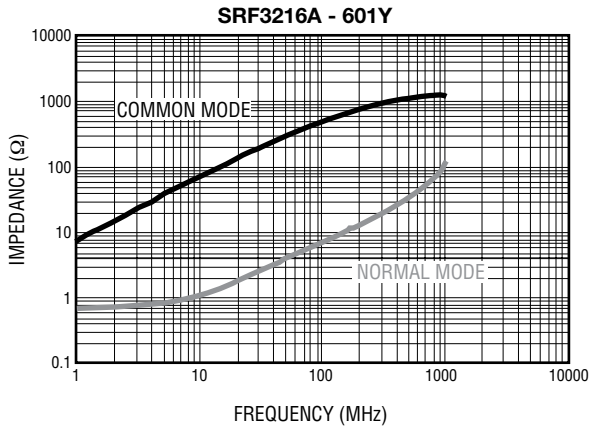

Specifications are subject to change without notice.
The device characteristics and parameters in this data sheet can and do vary in different applications and actual device performance may vary over time.
Users should verify actual device performance in their specific applications.

SRF3216A Series - Common Mode Chip Inductors

BOURNS®

Packaging Specifications

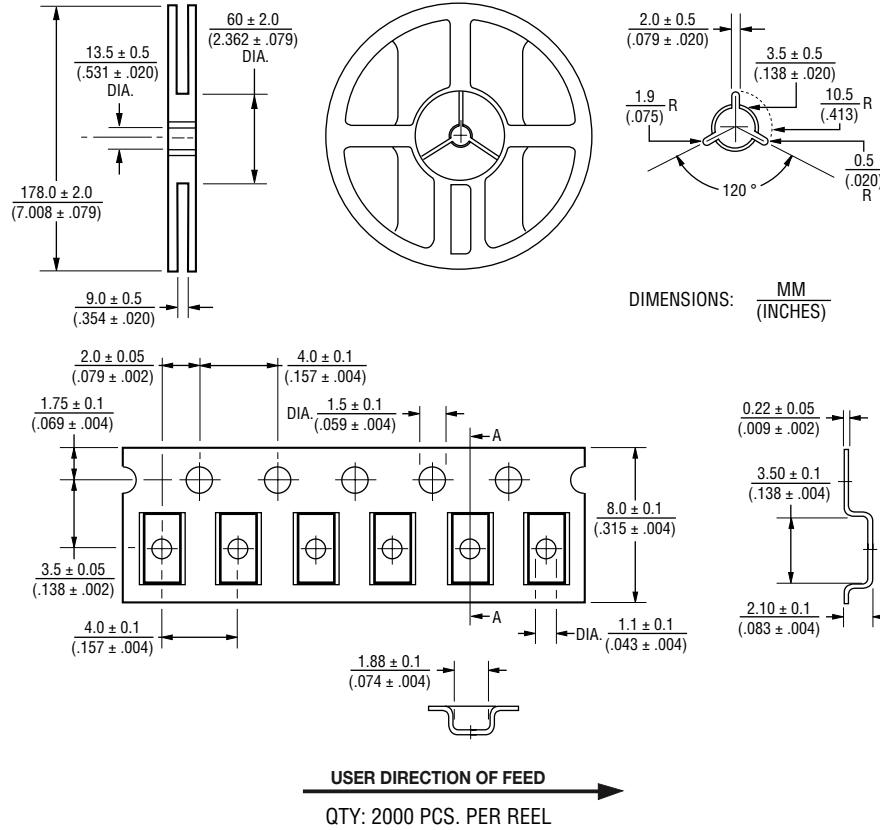

Mouser Electronics

Authorized Distributor

Click to View Pricing, Inventory, Delivery & Lifecycle Information:

Bourns:

[SRF3216A-900Y](#) [SRF3216A-121Y](#) [SRF3216A-161Y](#) [SRF3216A-221Y](#) [SRF3216A-261Y](#) [SRF3216A-361Y](#)
[SRF3216A-601Y](#) [SRF3216A-102Y](#) [SRF3216A-222Y](#)